

# MY PROJECT

**MK1**

## MY PROJECT

### VALORI p. 4

**My Project by Novacucina: made in Italy al servizio del progettista.**

VALUES

My Project by Novacucina: exclusiveness made in Italy.

### CUCINE p. 7

**Le forme dell'architettura ispirano cucine sartoriali curate in ogni dettaglio.**

KITCHENS

Architecture inspires meticulously designed bespoke kitchens.

### BAGNI p. 81

**Interni sofisticati dentro i quali la stanza da bagno è in primo piano.**

BATHROOMS

Sophisticated interiors place bathrooms to the fore.

### ANTE E DETTAGLI TECNICI p. 114

**MK1 è un'anta in alveolare di alluminio rivestita con materiali di pregio.**

DOORS AND TECHNICAL DETAILS

MK1 is a honeycomb aluminium door faced with attractive materials.

### MATERIALI p. 116

**I materiali della tradizione incontrano i materiali tecnici più innovativi.**

MATERIALS

Traditional materials encounter cutting edge technical ones.

**MK1**

## VALORI VALUES

### MADE IN ITALY

MADE IN ITALY

CULTURA DEL PROGETTO, QUALITÀ ECCELLENTE, SARTORIALITÀ. MY PROJECT BY NOVACUCINA SI RICONOSCE NEI VALORI CHE CARATTERIZZANO IL MADE IN ITALY.

IL MADE IN ITALY È UN SISTEMA DI PERSONE, CONOSCENZE E CAPACITÀ. DA UNA LUNGA ESPERIENZA NEL MONDO DELL'ARREDO E PER RISPONDERE ALLE ESIGENZE PIÙ ATTUALI DEL SETTORE DELL'INTERIOR DESIGN NASCONO LE PROPOSTE DI MY PROJECT, INTERNI SARTORIALI CARATTERIZZATI DA FORME CONTEMPORANEE, MATERIALI ECCELLENTI E DETTAGLI DALL'ALTO VALORE ARTIGIANALE. UN APPROCCIO INNOVATIVO CARATTERIZZA OGNI PROGETTO, DOVE GLI AMBIENTI DELLA CASA SONO PENSATI IN CONTINUITÀ, UN UNICUM ESTETICO ISPIRATO ALLE CARATTERISTICHE DEGLI SPAZI DI OGGI.

DESIGN CULTURE, EXCELLENT QUALITY, AND SARTORIAL EXECUTION: MY PROJECT BY NOVACUCINA IS DISTINGUISHED BY THE VALUES TYPICAL OF PRODUCTS MADE IN ITALY.

THE PHRASE 'MADE IN ITALY' INDICATES A SYSTEM OF PEOPLE, KNOWLEDGE AND SKILLS. THE ITEMS INCLUDED IN MY PROJECT ARE BASED ON MANY YEARS' EXPERIENCE IN INTERIOR DÉCOR AND DESIGNED TO MEET CONTEMPORARY NEEDS. BESPOKE INTERIORS FEATURE CONTEMPORARY SHAPES, EXCELLENT MATERIALS AND TOP QUALITY DETAILS ADDED BY SKILLED ARTISANS. AN INNOVATIVE APPROACH IS INHERENT IN EVERY PROJECT, WHICH CONSIDERS THE HOUSE A CONTINUOUS UNIT, AN AESTHETIC UNICUM INSPIRED BY MODERN CRITERIA REGARDING THE USE OF SPACE.

### AL SERVIZIO DEL PROGETTISTA

AT THE DESIGNER'S SERVICE

OGNI ARCHITETTURA HA LE SUE PECULIARITÀ E UN PROGETTO D'INTERNI PUÒ CONTRIBUIRE A VALORIZZARLE. PER CUCIRE OGNI INTERNO COME SE FOSSE UN ABITO SU MISURA, L'AZIENDA METTE A DISPOSIZIONE DEI PROGETTISTI INTERESSATI UN TEAM DEDICATO, ESPERTO NELLA PERSONALIZZAZIONE DI DIMENSIONI, FINITURE E CARATTERISTICHE DI OGNI ARREDO, ANCHE IN CHIAVE CONTRACT.

EACH TYPE OF ARCHITECTURE HAS ITS SPECIAL FEATURES AND AN INTERIOR DECOR PROJECT CAN HELP TO ENHANCE IT. TO TAILOR EVERY INTERIOR AS IF IT WERE A BESPOKE GARMENT, THE COMPANY PROVIDES THE DESIGNER INVOLVED WITH A TEAM OF EXPERTS IN CUSTOMISING DIMENSIONS, FINISHES AND SPECIAL FEATURES, ALSO FOR CONTRACT PROJECTS.

CUCINE  
KITCHENS



CUCINA . 1

MILANO, BOSCO VERTICALE. FUORI, PIÙ DI DUEMILA ESSENZE ARBOREE DANNO VITA A UNA FORESTA URBANA CONTEMPORANEA. DENTRO, OGNI STANZA DELLA CASA SI ADATTA A QUEST'ARCHITETTURA UNICA, RISPETTANDONE L'ESTETICA ED ESALTANDONE LE PARTICOLARITÀ.

KITCHEN . 1

MILAN, BOSCO VERTICALE. OUTSIDE, OVER TWO THOUSANDS TYPES OF TREES BRING TO LIFE A CONTEMPORARY URBAN FOREST. INSIDE, EACH ROOM IN THE HOME ADAPTS TO THIS UNIQUE ARCHITECTURE, IN TERMS OF AESTHETICS AND DETAILS.





**Per valorizzare la grande vetrata, la zona operativa si sviluppa ad angolo su due pareti, con cappa da soffitto in corrispondenza dei fuochi. Il tavolo al centro della stanza è in rovere torba, come la pannellatura della parete retrostante.**

In order to highlight the large window the work area develops in the corner created by two walls, with suspended extractor hood over the burners. The table in the middle of the room is in torba coloured oak, also used for the panelling behind it.



**Lo spazio di contenimento è molto ampio: oltre alla lunga parete a colonne con cantina integrata, nei pensili con anta vetro bronzato e telaio in alluminio si possono riporre oggetti d'uso quotidiano o da lasciare in vista.**

There is plenty of storage space: besides the long wall with tall units and integrated wine cellar, the wall units with aluminium framed bronze-finish glass doors can hold useful or decorative objects.







Nella base operativa con fuochi, l'apertura a gola è in una posizione insolita: non è sotto il top ma nella parte inferiore del cassetto. Così, nello spazio che viene a crearsi tra piano e cassetti, si possono inserire i comandi remoti.

The base unit with cooking hob has a grip profile in an unusual position: not under the top but in the lower part of the drawer. In this way, the space created between the top and drawer can house remote controls.

**SCHEMA TECNICA CUCINA . 1**  
 TECHNICAL INFO SHEET KITCHEN 1

**APERTURA A GOLA**  
 GRIP PROFILE

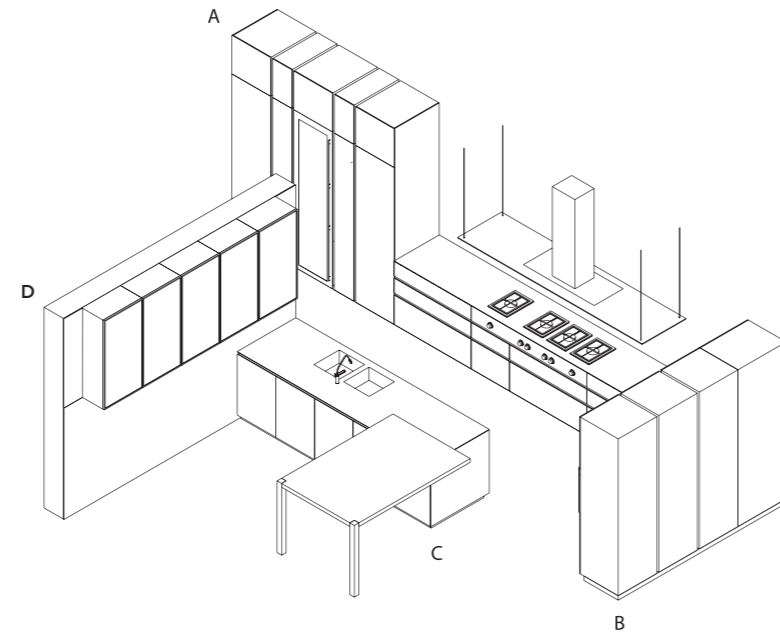
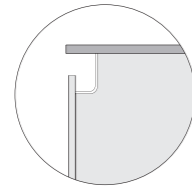

**MATERIALI**  
 MATERIALS



FENIX NTM®  
 GRIGIO EFESO



ROVERE TORBA



VETRO BRONZATO

**PIANTA**

- 1 cucina
- 2 living
- 3 pranzo
- 4 terrazzo

**LAYOUT**

- 1 kitchen
- 2 living room
- 3 dining room
- 4 balcony

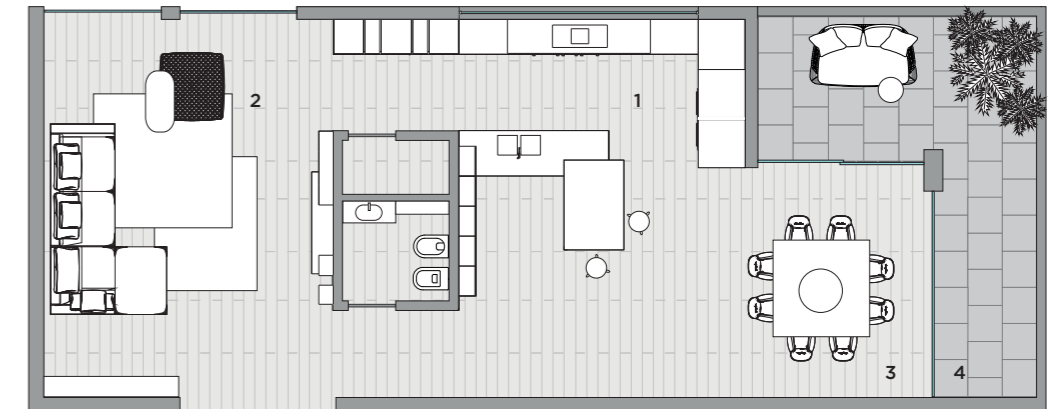

**A | COLONNE E BASI A PARETE**  
 tall unit and base units against wall

**B | COLONNE**  
 tall units

**C | ISOLA**  
 island

**D | PENSILI**  
 wall units

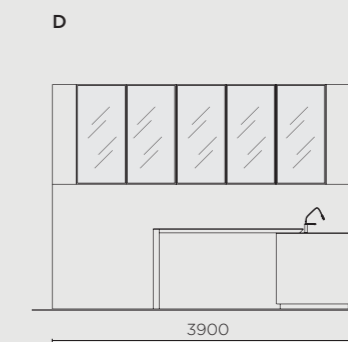
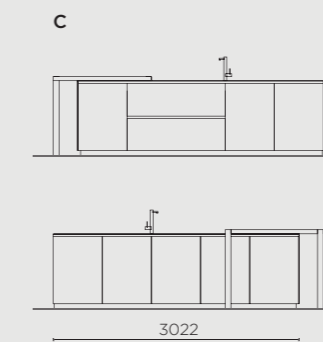
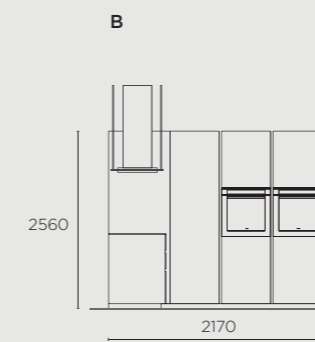
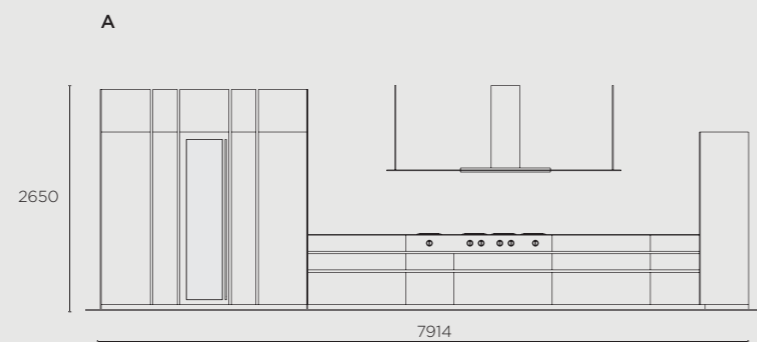



CUCINA . 2

LE FORME MODERNE E RAZIONALI DELL'ARCHITETTURA ISPIRANO QUELLE DELLA CUCINA. IL RISULTATO È UN INSIEME COERENTE DOVE PULIZIA FORMALE E RIGORE DETERMINANO ANCHE LE SCELTE PIÙ FUNZIONALI, COME QUELLA DI UNA ZONA OPERATIVA UNICA E CENTRALE.

KITCHEN . 2

MODERN, RATIONAL ARCHITECTURE INSPIRES THE SHAPE OF THIS KITCHEN. THE RESULT IS A COHERENT WHOLE FEATURING UNCLUTTERED, RIGOROUS LINES THAT DEFINE FUNCTIONAL ASPECTS SUCH AS THE SINGLE, CENTRAL WORK ZONE.





**Il vetro bianco dell'isola è riscaldato dalle finiture in rovere termocotto delle colonne attrezzate. Un sistema di ante a scomparsa nasconde gli elettrodomestici, mentre la cantina rimane a vista dietro le ante in vetro con telaio rivestito in legno e maniglie in acciaio a tutta altezza.**

The white glass of the island is softened by the heat treated oak finish of the equipped tall units. The appliances are concealed by a special system of doors, but the wine cellar remains on view behind wood trimmed glass doors with full length steel handle.



**Cucina e zona living sono pensate in continuità. Per ottenere un'armonia perfetta tra i due ambienti, il catalogo My Project include anche i pensili del soggiorno, realizzati con le stesse caratteristiche formali e le stesse finiture di quelli della cucina.**

The kitchen and living room are designed as a continuous module. To harmonise the two areas the My Project catalogue includes living room wall units with the same characteristics and finishes as those for the kitchen.





L'isola a due blocchi è unita dall'alto bancone in grès effetto pietra con fuochi integrati. La cappa da soffitto è rivestita in vetro bianco, come le ante delle basi, che hanno l'apertura a gola.

The two modules comprising the island are united by a high counter in stone effect stoneware with integrated cooking hob. The ceiling extractor hood is faced in white glass, like the base unit doors which feature a grip profile.

SCHEMA TECNICA CUCINA . 2

TECHNICAL INFO SHEET KITCHEN 2

APERTURA A GOLA  
/ isola

GRIP PROFILE  
/ island

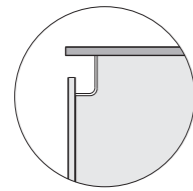

APERTURA CON MANIGLIA  
/ colonne

HANDLE  
/ tall units

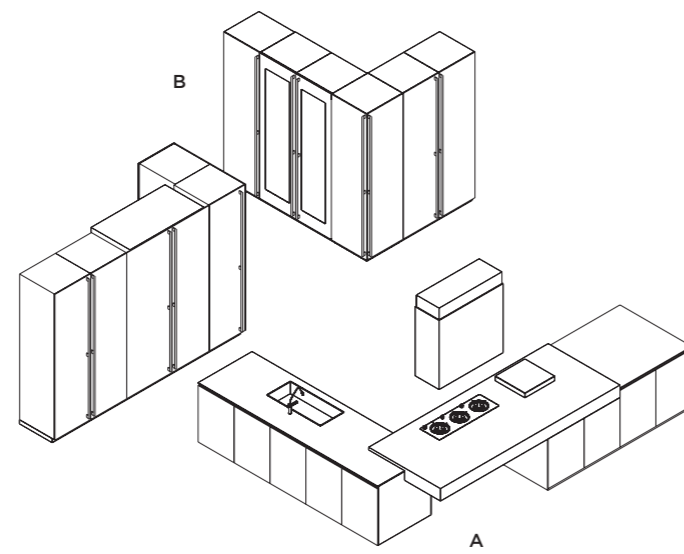
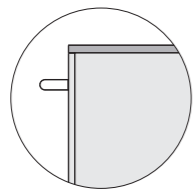

MATERIALI  
MATERIALS



ROVERE TERMOCOTTO VETRO OPACO BIANCO GRÈS FOKOS ROCCIA

PIANTA

- 1 cucina
- 2 pranzo
- 3 living
- 4 patio

LAY OUT

- 1 kitchen
- 2 living room
- 3 dining room
- 4 patio

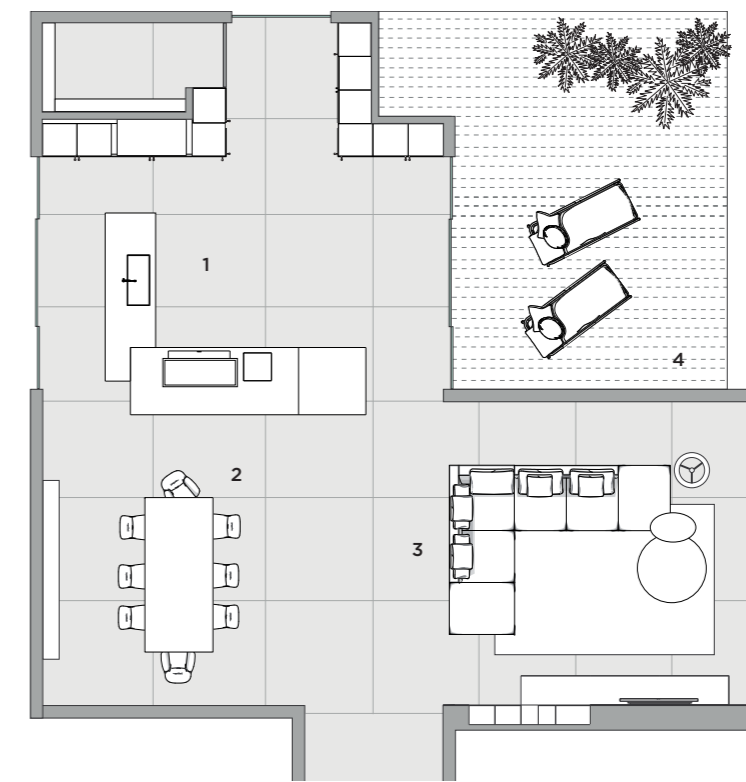

A | ISOLA  
island

B | COLONNE  
tall units

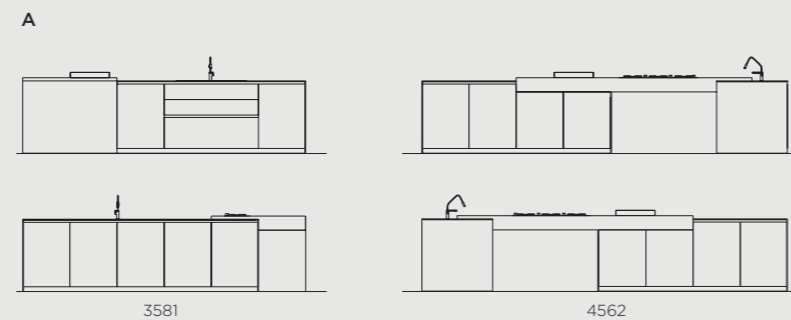





CUCINA . 3

UNA CORNICE CLASSICA PER UNA CUCINA MODERNA NELLE FORME E NELLE FINITURE.  
LA GEOMETRICA SEMPLICITÀ DELL'ISOLA E DEI PENSILI SI ARMONIZZA CON GLI STUCCHI  
E LA BOISERIE DI QUESTO APPARTAMENTO AL PIANO NOBILE DI UN ANTICO PALAZZO.

KITCHEN . 3

A CLASSICAL SETTING FOR MODERN KITCHEN FITTINGS. THE GEOMETRICAL SIMPLICITY  
OF THE ISLAND AND WALL UNITS BLENDS IN WITH THE STUCCO AND BOISERIE OF THIS  
FLAT ON THE MAIN FLOOR OF AN ANCIENT MANSION.





**L'attenzione ai dettagli detta un'estetica sofisticata e funzionale, anche all'interno dei cassetti accessoriati della zona operativa, caratterizzata da top e blocco lavabo in pietra grey.**

Attention to details gives a sophisticated, functional look, also inside the accessory-fitted drawers of the work area, which features tops and sink unit in grey stone.



**A circondare il blocco operativo, che ha le stesse finiture bronzo dell'isola a doppia altezza, colonne e pensili in appoggio con anta in vetro fumé e telaio in alluminio.**

Surrounding the work module, which has the same bronze finish as the split-top island, are tall units and free-standing wall units with aluminium framed, smoked glass doors.





SCHEMA TECNICA CUCINA . 3

TECHNICAL INFO SHEET KITCHEN 3

APERTURA A GOLA  
/ isola  
/ basi

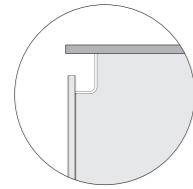

GRIP PROFILE  
/ island  
/ base units

APERTURA CON MANIGLIA  
/ colonne

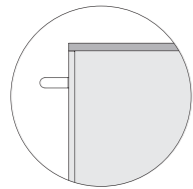

HANDLE OPENING  
/ tall units

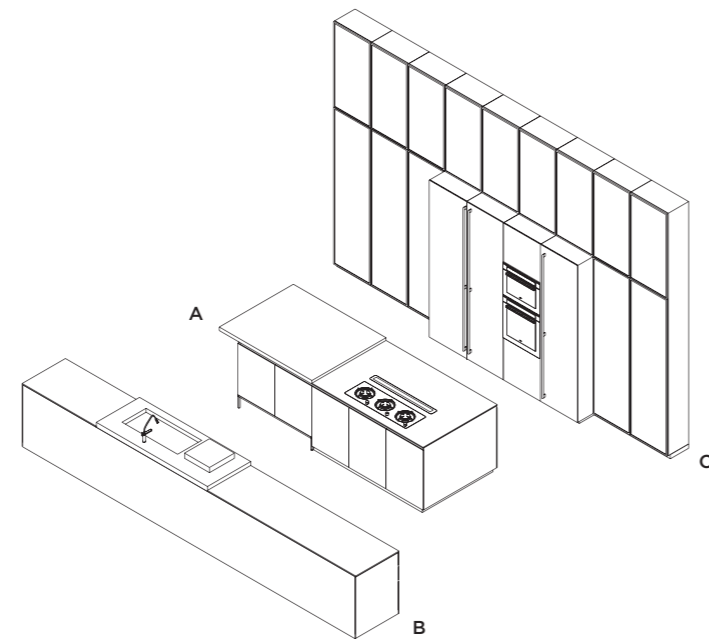

MATERIALI  
MATERIALS



ALLUMINIO BRONZO



MARMO DARK GREY



VETRO GRIGIO FUMÉ

PIANTA

- 1 cucina
- 2 living
- 3 terrazzo

LAYOUT

- 1 kitchen
- 2 living
- 3 balcony

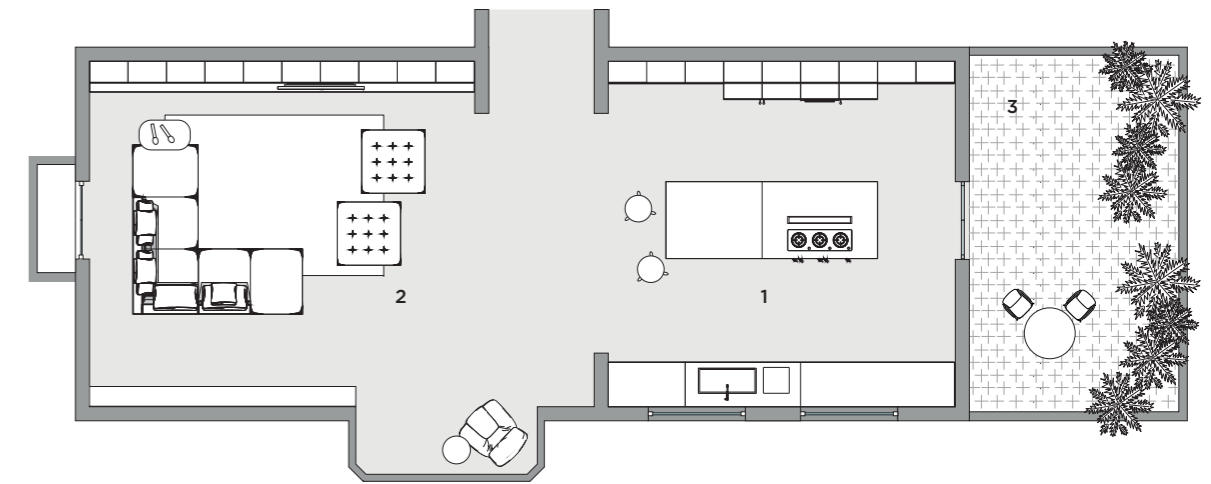

A | ISOLA  
island

B | BASI A PARETE  
base units against wall

C | COLONNE  
tall units

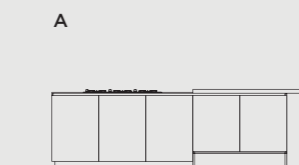

3022

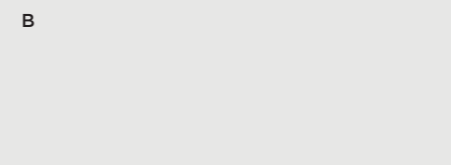

5422



5400

3370



CUCINA . 4

NEL PATIO DI UNA VILLA MODERNA IN UNA GIORNATA DI SOLE, IL RIVERBERO DELLA LUCE SULLE VETRATE DELLA ZONA GIORNO LASCIA INTRAVEDERE UNA CUCINA DALLE DIMENSIONI IMPORTANTI, CARATTERIZZATA DA UN'ISOLA CON CAPPA SOSPESA IN ACCIAIO E DA MODULI OPERATIVI SU PIÙ PARETI.

KITCHEN . 4

ON THE SUNLIT PATIO OF A MODERN VILLA THE LIGHT REFLECTS ON THE LARGE WINDOWS TO REVEAL A GLIMPSE OF AN IMPOSING KITCHEN FEATURING AN ISLAND WITH SUSPENDED STEEL EXTRACTOR HOOD AND WORK UNITS ON THE WALLS.

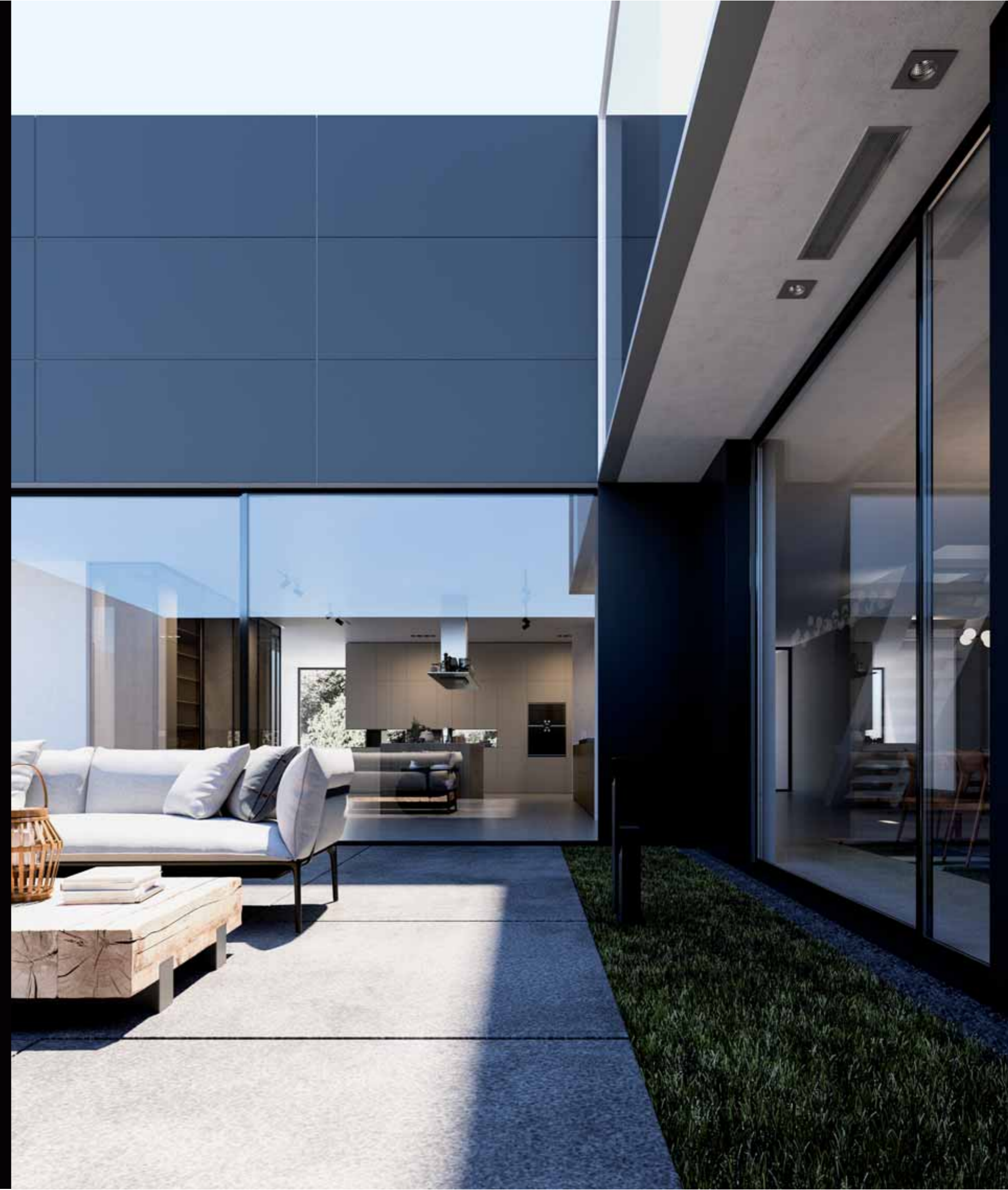





**Pulizia formale assoluta con l'anta ad apertura push-pull impiallacciata in noce, che si allunga fino a terra per coprire lo zoccolo dell'isola.**

The door with push-pull opening creates an uncluttered look. Walnut veneered, it extends to the floor to cover the island plinth.



**Un box in vetro racchiude la zona dedicata alla cantina e alla dispensa, con boiserie e colonne in laccato opaco grigio corda. La stessa finitura ritorna nella parete che separa la cucina dalla zona living.**

Glass boxing encloses the area dedicated to the wine cellar and pantry, with grey cord matt lacquered boiserie and tall units. The same finish is repeated for the wall separating the kitchen from the living room.





È in acciaio sottile il top dell'isola con fuochi integrati, così come quello della zona operativa a parete con blocco lavaggio alto 6 cm. Qui, tra il piano e i pensili, trovano posto elementi contenitori per barattoli, mestoli e altri accessori.

The top with integrated cooking hob is in slim steel, just like the work area against the wall, with 6cm high sink unit. The space between the top and wall units houses storage elements for jars, ladles and other accessories.

SCHEMA TECNICA CUCINA . 4

TECHNICAL INFO SHEET KITCHEN 4

APERTURA PUSH-PULL

- / isola A
- / basi e pensili B
- / colonne D

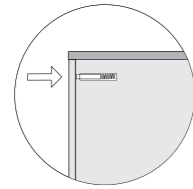

PUSH-PULL

- / island A
- / base units and wall units B
- / tall units D

APERTURA CON MANIGLIA

- / colonne C

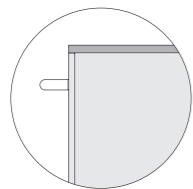

- HANDLE
- / tall units C

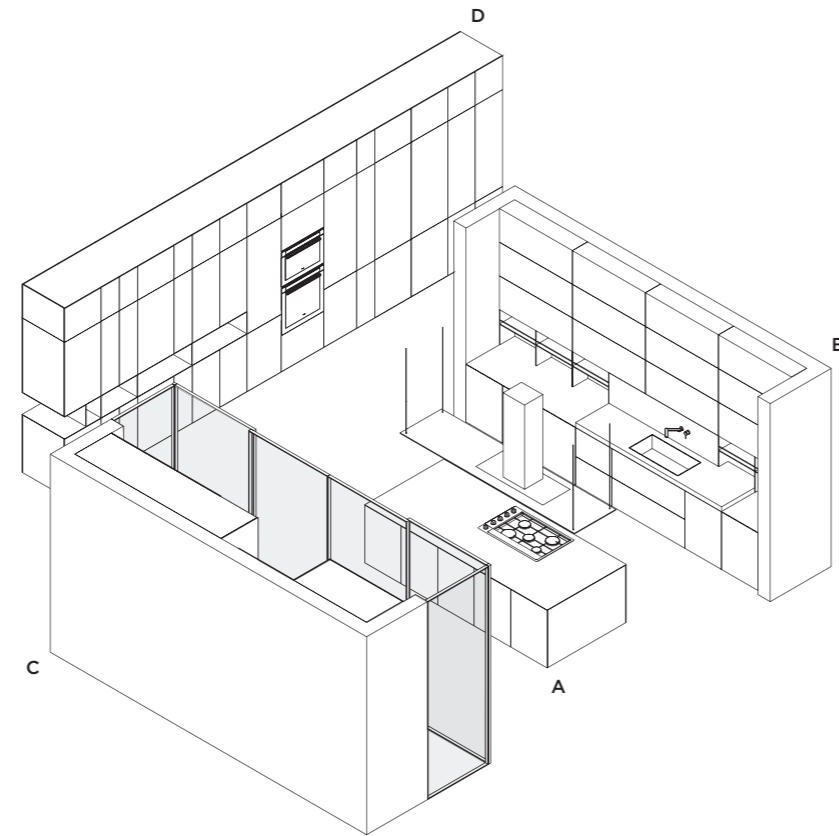

MATERIALI  
MATERIALS



NOCE CANALETTO



LACCATO OPACO  
205 GRIGIO FOSSILE



RESINA CEMENTO  
SILVER GREY



ACCIAIO INOX

PIANTA

- 1 cucina
- 2 living
- 3 pranzo
- 4 patio

LAYOUT

- 1 kitchen
- 2 living room
- 3 dining room
- 4 patio

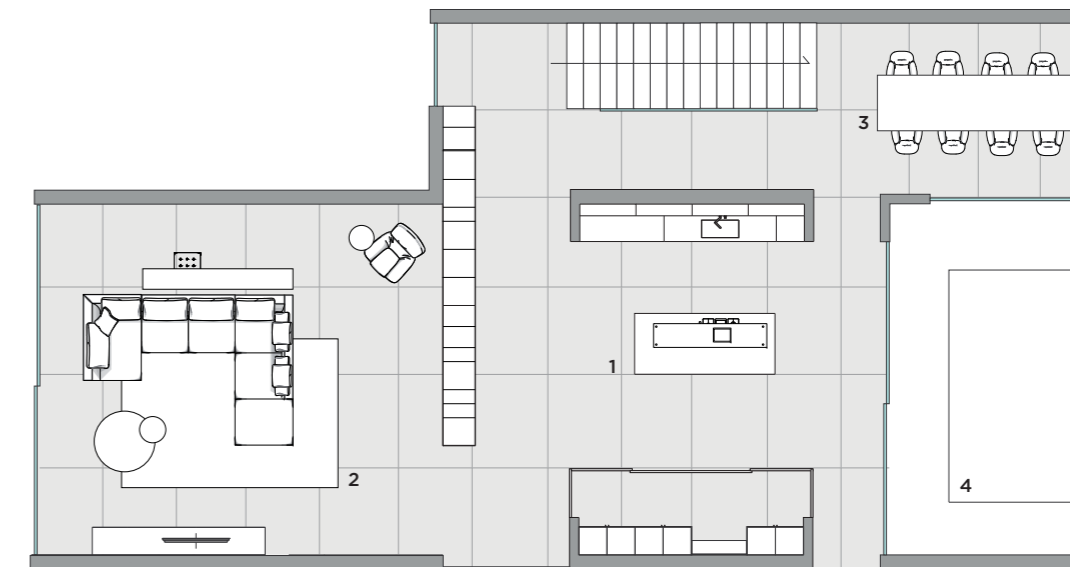

A | ISOLA  
island

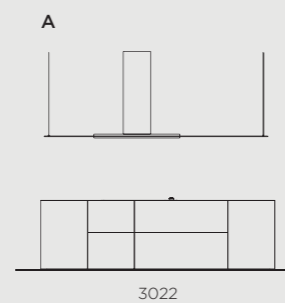

B | BASI  
base units

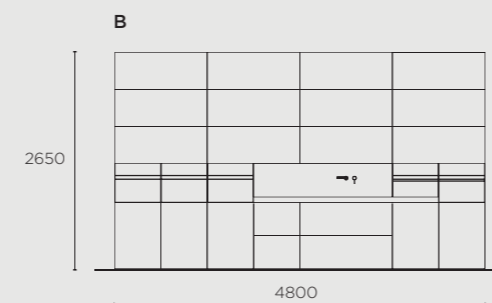

C | COLONNE  
tall units

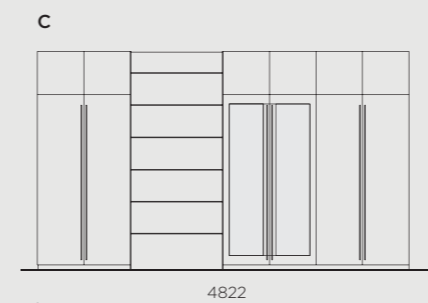

D | COLONNE  
tall units

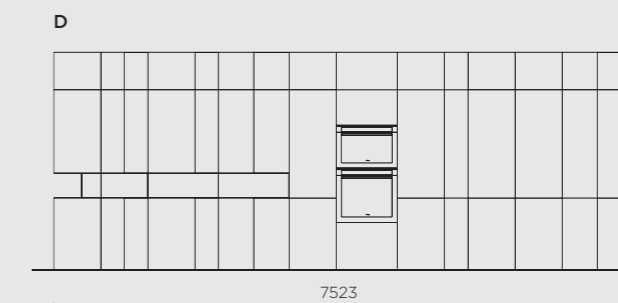



CUCINA . 5

È IMMERSA NEL PAESAGGIO NATURALE QUESTA VILLA DALLE AMPIE FINESTRE E CON INTERNI D'ISPIRAZIONE NORDICA. BOISERIE E ARREDI GIOCATI SUL NERO SONO RISCALDATI DALLE FINITURE IN LEGNO E DAL CAMINO CHE DIVIDE LA CUCINA DALLA ZONA GIORNO.

KITCHEN . 5

A NATURAL LANDSCAPE SURROUNDS THIS VILLA WITH LARGE WINDOWS AND NORDIC INSPIRED INTERIORS. BOISERIE AND BLACK ITEMS ARE SOFTENED BY WOOD FINISHES AND THE FIREPLACE DIVIDING THE KITCHEN FROM THE LIVING ROOM.





**L'alluminio finitura ferro naturale caratterizza la boiserie con mensole e l'isola, che ha prese di corrente da piano e top in Dekton, un materiale rivoluzionario ricavato dalla miscela delle migliori materie prime usate nella produzione di vetro, materiali ceramici e quarzo.**

Natural iron aluminium distinguishes the boiserie with shelves and the island, which has counter top power sockets and a top in Dekton, a revolutionary material made of a mix of quality raw materials used in the production of glass, ceramics and quartz.



**Le colonne, in rovere naturale come le mensole da 1,2 cm, sono attrezzate all'interno con prese di corrente e piano estraibile in acciaio. Così, si viene a creare un ulteriore spazio di lavoro - anche con piccoli elettrodomestici - disponibile all'occorrenza.**

The tall units in natural oak, like the 1.2cm shelves, are equipped with sockets and pull-out steel top. This creates further work space - also with small appliances - available as and when needed.







I cassetti con apertura a gola a presa inferiore sono in linea con l'estetica pulita e rigorosa di questa cucina.

Drawers with lower grip profiles are in line with the uncluttered, clean-cut appearance of this kitchen.

SCHEMA TECNICA CUCINA . 5

TECHNICAL INFO SHEET KITCHEN 5

APERTURA A GOLA  
/ isola

GRIP PROFILE  
/ island

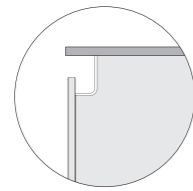

APERTURA CON MANIGLIA  
/ colonne

HANDLE  
/ tall units

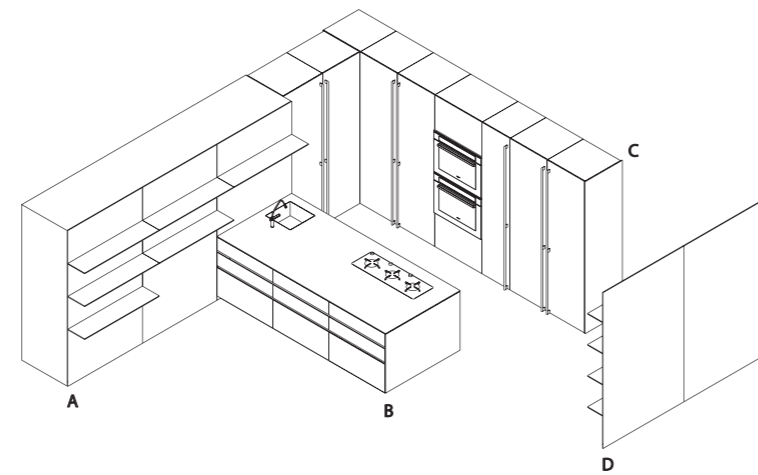
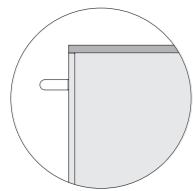

MATERIALI  
MATERIALS



ALLUMINIO FERRO  
NATURALE



ROVERE NATURALE



DEKTON SIRIUS NERO

PIANTA

- 1 cucina
- 2 pranzo
- 3 living

LAYOUT

- 1 kitchen
- 2 dining room
- 3 living room

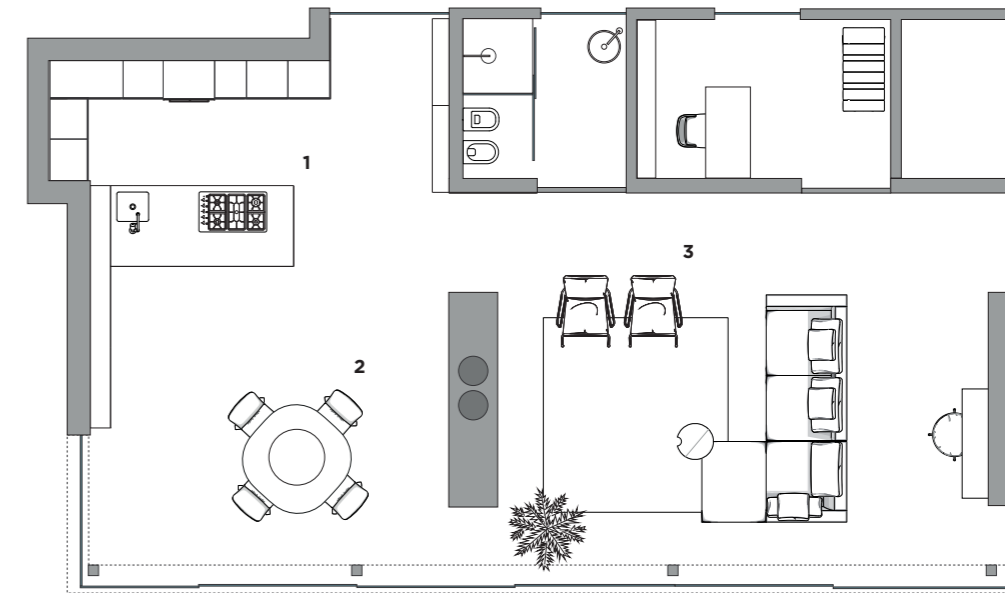

A BOISERIE  
boiserie

B ISOLA  
island

C COLONNE  
tall units

D BOISERIE  
boiserie

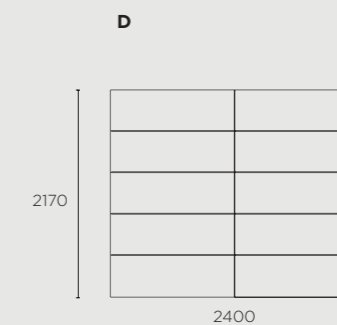
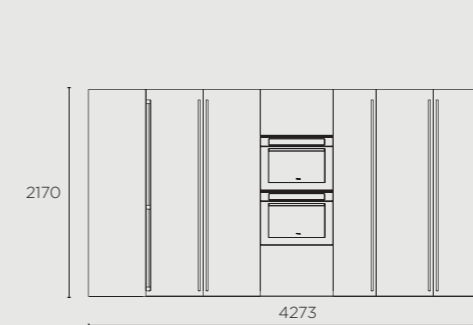
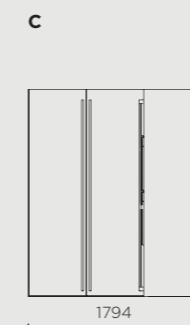
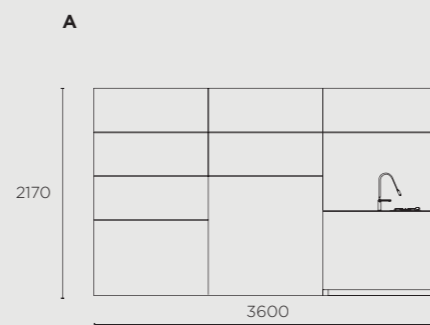



CUCINA . 6

UN LOFT RICAVATO NELLO SPAZIO SOTTO UN TETTO A DOPPIA FALDA E UNA CUCINA CHE NE SFRUTTA TUTTE LE POTENZIALITÀ FUNZIONALI ED ESTETICHE, GRAZIE ALLE COLONNE SU MISURA E ALLE FINITURE DI PREGIO COME IL CORIAN® E IL ROVERE NATURALE.

KITCHEN . 6

A LOFT CREATED IN THE SPACE UNDER A PITCHED ROOF AND A KITCHEN THAT MAKES FULL USE OF ALL ITS FUNCTIONAL AND AESTHETIC POTENTIAL, USING CUSTOMISED TALL UNITS AND QUALITY FINISHES SUCH AS CORIAN® AND NATURAL OAK.





**Nel cassetto attrezzato sotto il blocco cottura sono riordinate pentole e accessori per cucinare, facilmente accessibili grazie all'apertura a gola.**

The equipped deep drawer under the cooking unit contains pans and cooking utensils, easily accessible by means of the grip profile.

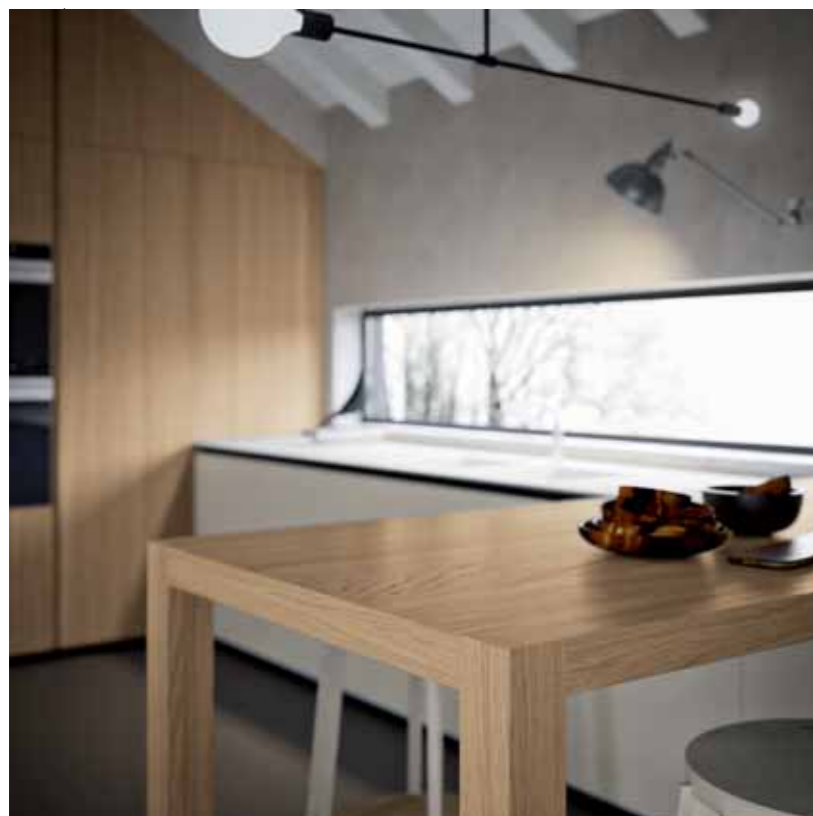

**Il tavolo in rovere naturale dà vita a una zona conviviale. Il piano è in appoggio sulla base, che ha il top con vasche integrate in Corian®, una solid surface innovativa che mantiene la sua bellezza inalterata nel tempo.**

The table in solid-effect natural oak enlivens an area in which to entertain. The top stands next to the base unit, which has an integrated sink unit in Corian®, an innovative solid surface whose beauty remains intact over time.





Le particolarità architettoniche ispirano soluzioni su misura. In questo caso, le basi ospitano ciascuna un blocco operativo: il blocco lavaggio si trova in corrispondenza della finestra mentre i fuochi sono sulla parete opposta, insieme a pensili e ripiani accessoriati.

Architectural details inspire customised solutions. In this case each base unit houses a work unit: the sink unit is placed under the window and the cooking hob is on the opposite wall, together with wall units and accessorised shelves.

## SCHEMA TECNICA CUCINA . 6

TECHNICAL INFO SHEET KITCHEN 6

APERTURA A GOLA  
GRIP PROFILE

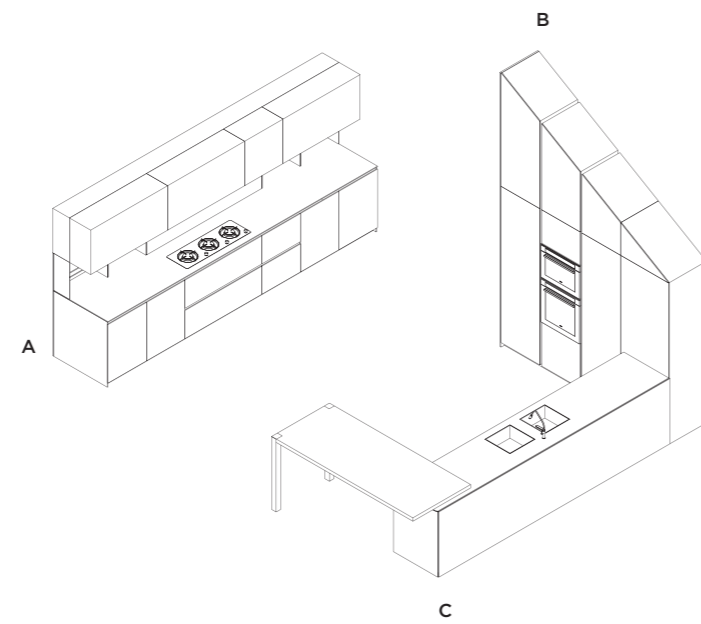
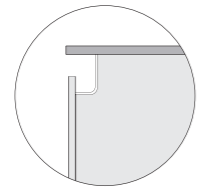

MATERIALI  
MATERIALS



ROVERE NATURALE



LACCATO OPACO  
200 BIANCO GHIACCIO

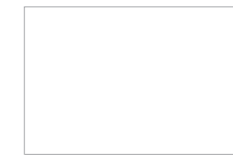

CORIAN®

PIANTA

- 1 cucina
- 2 pranzo
- 3 living

LAYOUT

- 1 kitchen
- 2 dining room
- 3 living room

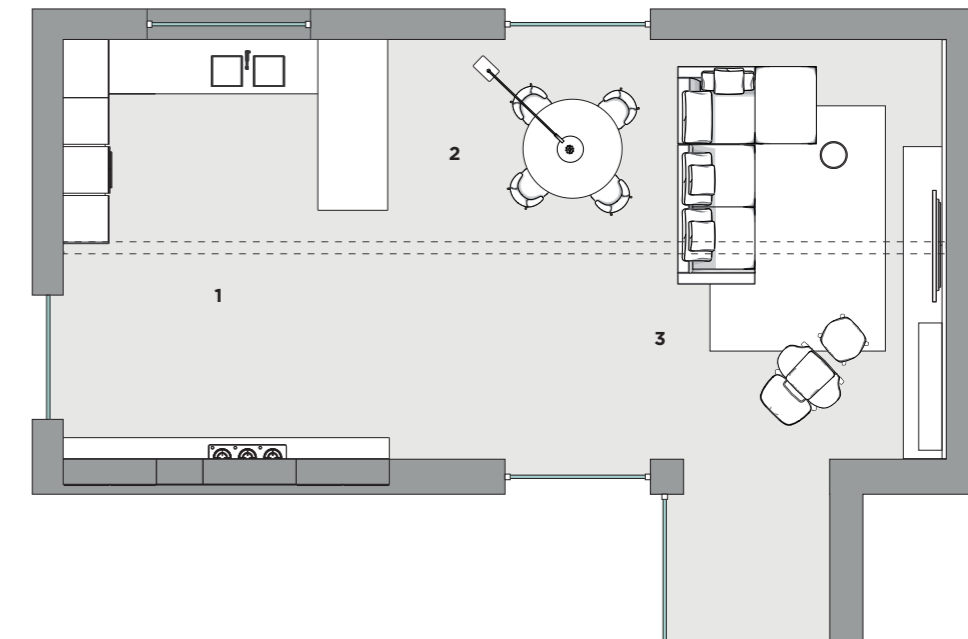

A | BASI A PARETE 2

base units against wall 2

B | COLONNE

tall units

C | BASI A PARETE 1

base units against wall 1

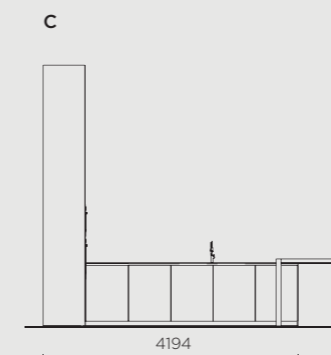
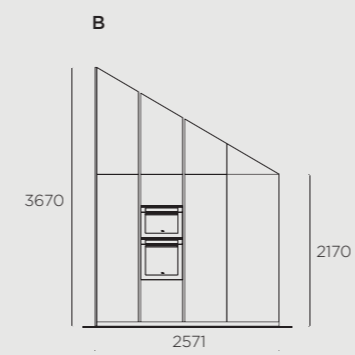
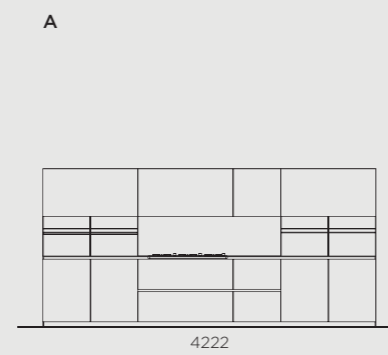



BAGNI

BATHROOMS



BAGNO . 1

UN INTERNO CONTEMPORANEO CARATTERIZZATO DA SOFFITTI ALTI E FINITURE LUSUOSE. NELLA STANZA DA BAGNO, LE LUCI SOFFUSE ACCAREZZANO LE PARETI IN PIETRA GREY E I PENSILI A INCASSO CON TELAIO IN ALLUMINIO NERO E ANTA IN VETRO FUMÉ.

BATHROOM . 1

A CONTEMPORARY INTERIOR FEATURING HIGH CEILINGS AND LUXURY FINISHES. IN THE BATHROOM THE SOFT LIGHTS CARESS THE GREY STONE WALLS AND INSET ALUMINIUM-FRAMED WALL UNITS WITH SMOKED GLASS DOORS.





**Sulla base sospesa in noce con anta ad apertura push-pull, due lavabi sopra piano in solid surface e gli specchi alti fino al soffitto creano una doppia postazione.**

The walnut suspended base unit with push-pull door and two sit-on solid surface wash basins with tall mirrors up to the ceiling create a double vanity unit.

SCHEDA TECNICA BAGNO . 1

TECHNICAL INFO SHEET BATHROOM 1

MATERIALI  
MATERIALS



NOCE CANALETTO



VETRO GRIGIO FUMÉ

APERTURA PUSH-PULL  
PUSH-PULL

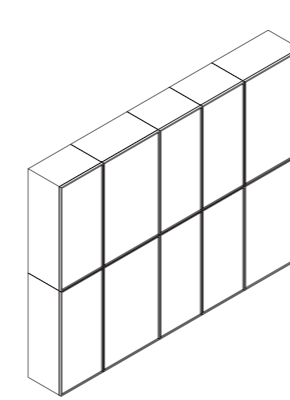
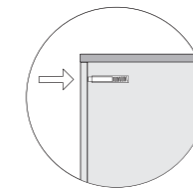

B

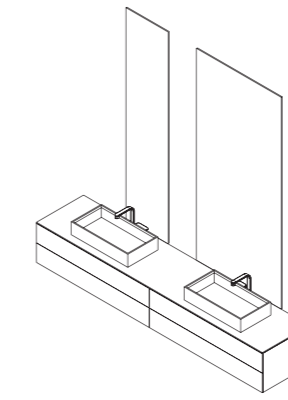

A

PIANTA  
LAYOUT

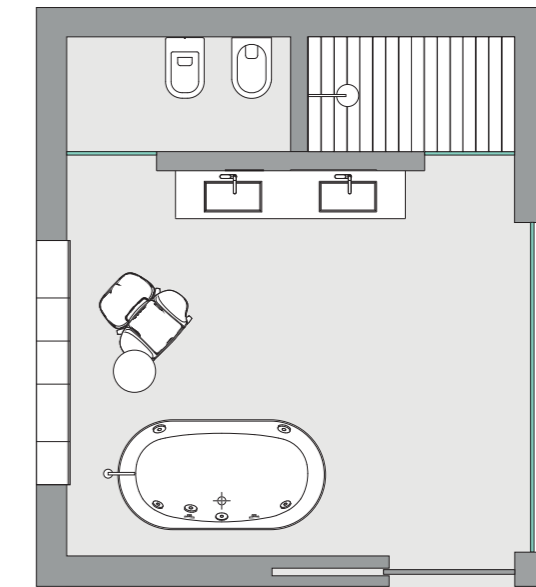

A BASI LAVABO  
vanity unit

B COLONNE  
tall units

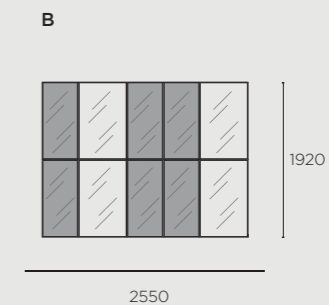
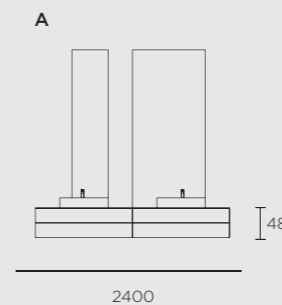



BAGNO . 2

LA CARATTERISTICA LEGGEREZZA DI QUESTO INTERNO È MANTENUTA ANCHE NELLA STANZA DA BAGNO, DOMINATA DAL BIANCO, AMPIA E ARIOSA NONOSTANTE LA SUDDIVISIONE FUNZIONALE DEGLI SPAZI, SEPARATI ANCHE ARCHITETTONICAMENTE.

BATHROOM . 2

THE AIRY EFFECT OF THIS INTERIOR DECOR IS MAINTAINED IN THE PREVALENTLY WHITE BATHROOM, LARGE AND AIRY NOTWITHSTANDING THE DIVISION OF SPACE SEPARATED ARCHITECTURALLY.





**In questa stanza lo spazio contenitivo è molto ampio. Oltre ai vani della base sospesa con blocco lavaggio in grès effetto marmo, tessili da bagno e altri oggetti si possono riporre dentro le alte colonne incassate a parete, in laccato opaco bianco con ante centrali a specchio.**

This room features lots of storage space. Besides the compartments in the suspended base unit with marble effect stoneware wash basin, bathroom linen and other objects can be stored in the white matt lacquered tall inset wall units with mirrors on the centre doors.



SCHEDA TECNICA BAGNO . 2

TECHNICAL INFO SHEET BATHROOM 2

MATERIALI  
MATERIALS



LACCATO OPACO  
200 BIANCO GHIACCIO

GRÈS MARMO  
STATUARIO

PIANTA  
LAYOUT

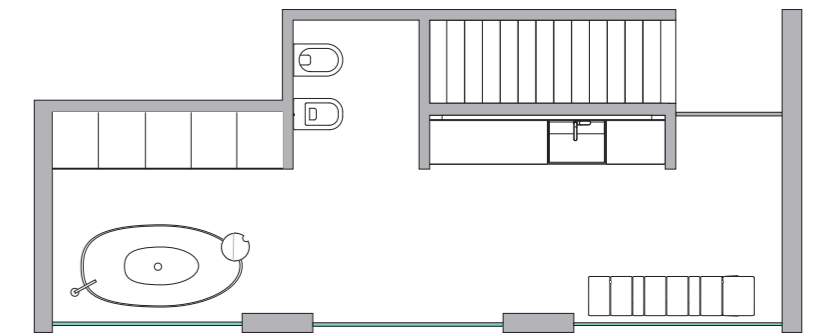

APERTURA PUSH-PULL  
PUSH-PULL

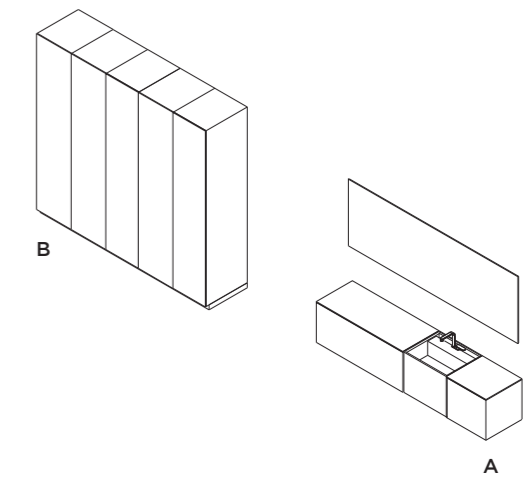
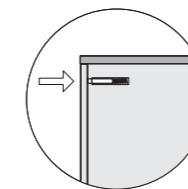

A BASI BAGNO  
bathroom unit

B COLONNE  
tall units

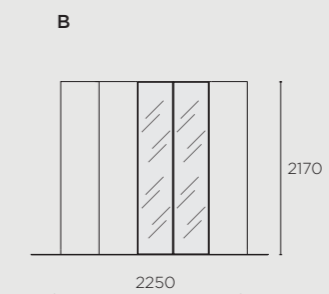
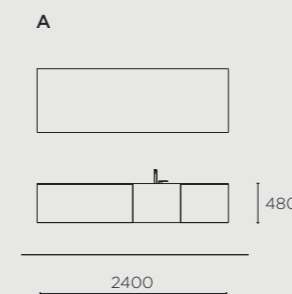



BAGNO . 3

IL MINIMALISMO DELL'ARCHITETTURA ISPIRA TUTTI GLI AMBIENTI DELLA CASA. NELLA STANZA DA BAGNO LE DIVERSE ZONE SONO SEPARATE DA PARETI IN VETRO FUMÉ, CHE RENDONO ESCLUSIVA QUESTA COMPOSIZIONE.

BATHROOM . 3

THE MINIMALISM OF THE ARCHITECTURAL STRUCTURE INSPIRES THE ENTIRE HOUSE. IN THE BATHROOM THE DIFFERENT AREAS ARE SEPARATED BY SMOKED GLASS PARTITIONS THAT MAKE THIS COMPOSITION EXCLUSIVE.





**Il lavabo a catino è appoggiato sul mensolone in rovere old effetto massello. La funzione contenitiva è svolta dai pensili in laccato grigio corda e dal modulo bianco a libreria incassato a muro.**

The wash bowl sits on the solid-effect old oak shelf. Storage is provided by the grey cord lacquered wall units and the white bookcase module inset into the wall.

**SCHEDA TECNICA** BAGNO . 3

TECHNICAL INFO SHEET BATHROOM 3

**MATERIALI**  
MATERIALS



LACCATO OPACO  
200 BIANCO GHIACCIO



LACCATO OPACO  
205 GRIGIO FOSSILE



ROVERE OLD NATURALE

**APERTURA PUSH-PULL**  
PUSH-PULL

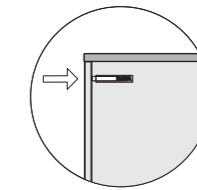

**PIANTA**  
LAYOUT

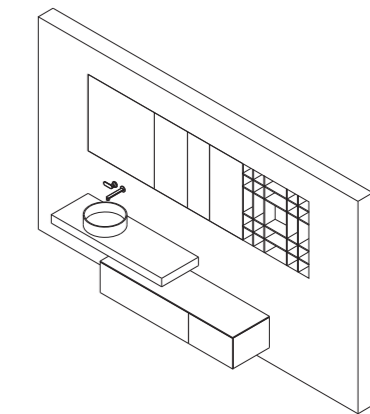
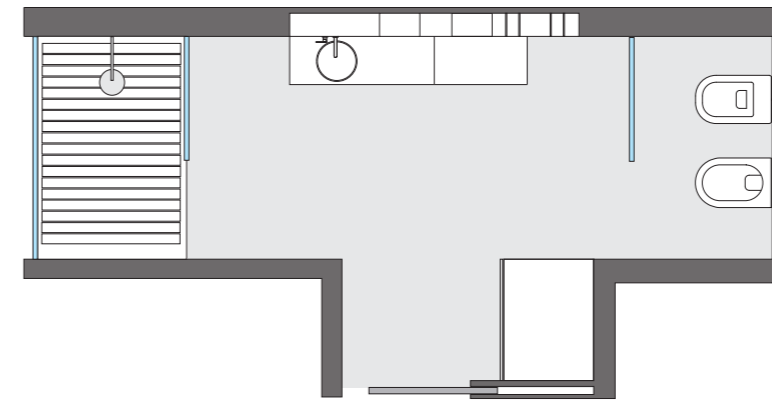

**ARREDO BAGNO**  
bathroom furniture

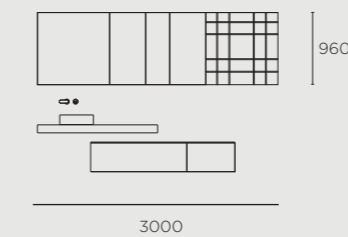



BAGNO . 4

LE FINITURE DI PREGIO CARATTERIZZANO QUESTA STANZA DA BAGNO AMPIA E LUMINOSA. IL MARMO STATUARIO BIANCO DELLE PARETI SI RITROVA ANCHE NELLA PEDANA RIALZATA, CHE SOSTIENE LA VASCA DA BAGNO E SU CUI POGGIA LA LUNGA BASE IN ALLUMINIO TINTA FERRO NATURALE.

BATHROOM . 4

QUALITY FINISHES DISTINGUISH THIS LARGE, LUMINOUS BATHROOM. THE STATUARY WHITE MARBLE OF THE WALLS IS ALSO USED FOR THE RAISED PLATFORM SUPPORTING THE BATH TUB AND HOUSING THE LONG NATURAL IRON COLOURED ALUMINIUM BASE UNIT.





È un contrasto armonico quello tra il top in finitura alluminio dall'aspetto satinato e il lavabo a catino in Corian® bianco, morbido e luminoso.

A well-balanced contrast is provided between the brushed aluminium top and the soft luminosity of the white Corian® wash bowl.



SCHEDA TECNICA BAGNO . 4

TECHNICAL INFO SHEET BATHROOM 4

MATERIALI  
MATERIALS



ALLUMINIO FERRO  
NATURALE

APERTURA A GOLA  
GRIP PROFILE

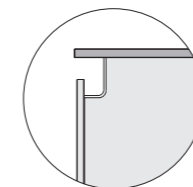

PIANTA  
LAYOUT

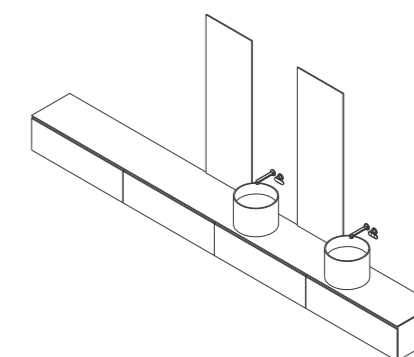
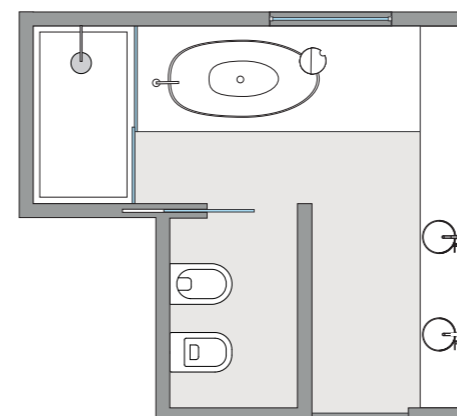

ARREDO BAGNO  
bathroom furniture

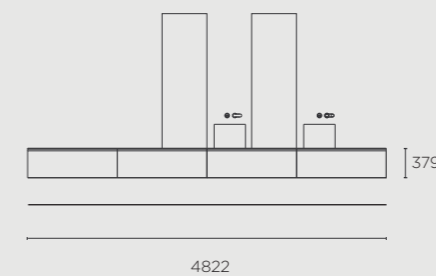

## ANTE E DETTAGLI TECNICI

DOORS AND TECHNICAL DETAILS

### SISTEMI DI APERTURA OPENING SYSTEMS

**Gola, push-pull, maniglia.** I tre diversi sistemi di apertura del catalogo My Project sono pensati per rispondere a ogni esigenza estetica e funzionale: la classica gola in alluminio personalizzabile crea giochi d'ombra e profondità; l'apertura push-pull regala pulizia assoluta all'anta; la maniglia diventa un dettaglio di stile.

Grip profiles, push-pull and handles. The three different opening systems in the My Project catalogue are designed to meet all aesthetic and functional needs: a classical grip profile in paintable aluminium creates a light and shade effect; a push-pull system gives the door clean-cut lines; a handle becomes a stylish detail.

#### ANTA A apertura a gola

#### ANTA B apertura push-pull

#### ANTA C apertura con maniglia

DOOR A  
grip profile

DOOR B  
push pull

DOOR C  
handle

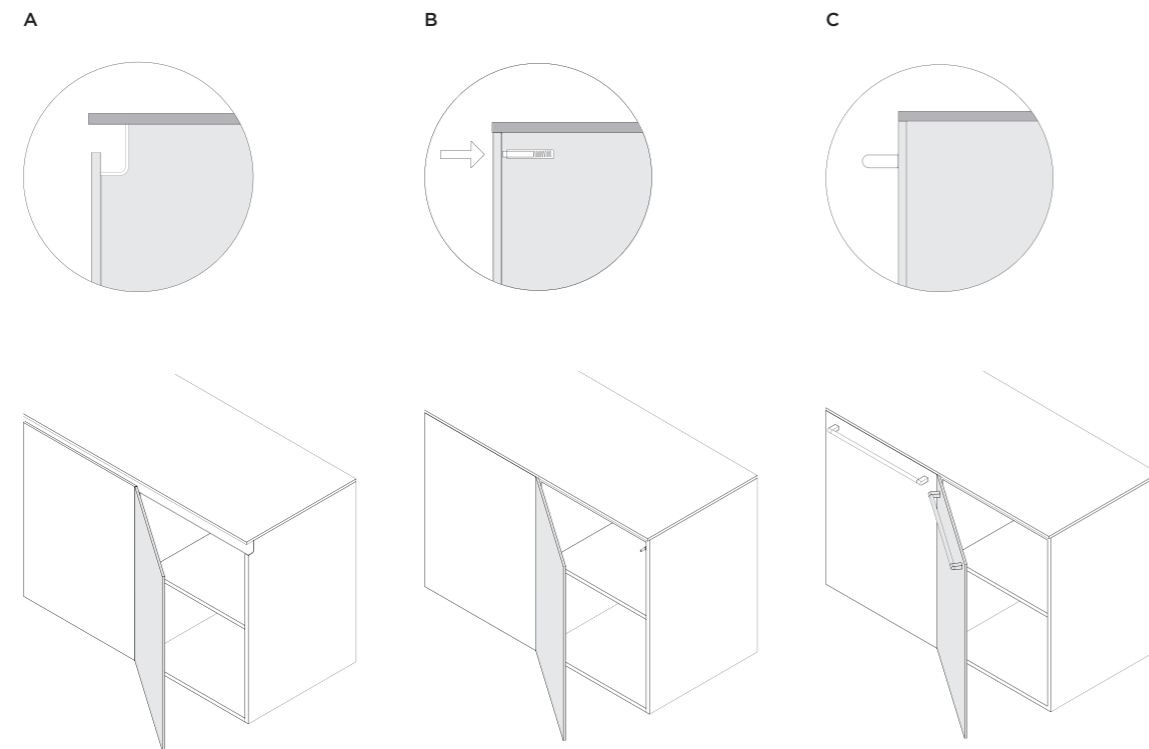

#### ANTA MK1 MK1 DOOR

L'anta MK1, spessa 12 mm, è in alveolare di alluminio, un materiale indeformabile estremamente resistente, leggero e riciclabile. All'esterno vi si può applicare una lastra di vetro, oppure l'anta si può rivestire a scelta con tutti i materiali del catalogo My Project: legno, Fenix NTM®, laccato opaco o lucido, resina cemento, laccato metallo.

The 12mm thick MK1 door is in aluminium honeycomb, an indestructible material that's extremely strong, light weight and recyclable. It can be faced with glass or doors can be faced with a choice of any of the materials in the My Project catalogue: wood, Fenix NTM®, matt or glossy lacquered, concrete resin and lacquered metal.

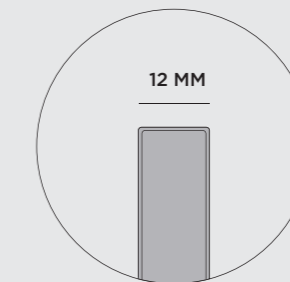

#### ANTA SEZIONATA DOOR WITH SECTIONS



anta vetro + 4 mm  
glass door + 4 mm

anta legno  
wood door

anta FENIX NTM®  
fenix NTM® door

anta laccato metallo  
metal lacquered door

anta laccato  
lacquered door

anta cemento  
concrete finish door

MATERIALI  
MATERIALS

FENIX NTM®



LACCATI OPACHI E LUCIDI  
MATT AND GLOSSY LACQUERED



LACCATI EFFETTO METALLO OSSIDATO  
LACQUERED WITH OXIDIZED METAL EFFECT



LEGNO  
WOOD

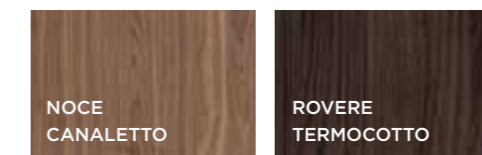

LEGNO  
WOOD

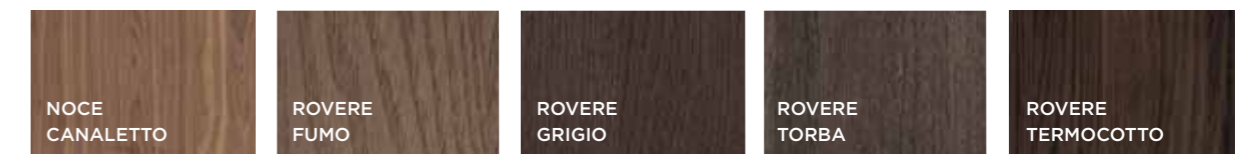
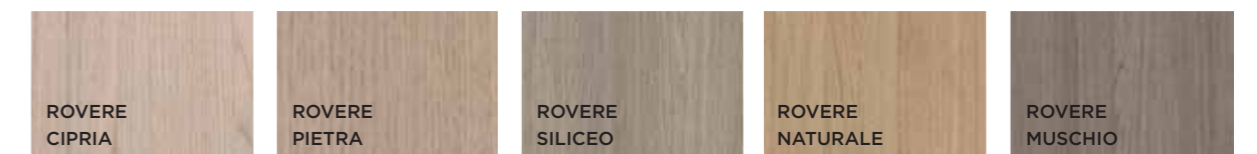

RESINA CEMENTO  
CEMENT RESIN

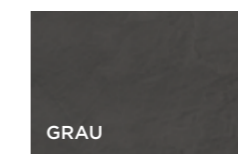

LACCATO METALLO  
LACQUERED METAL

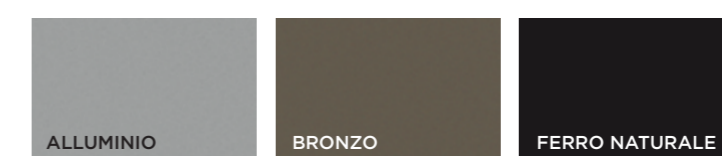

VETRO OPACO E LUCIDO  
GLOSSY AND MATT GLASS

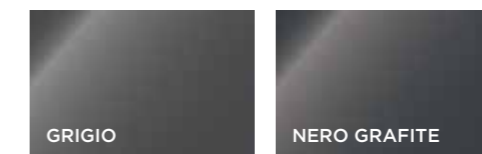
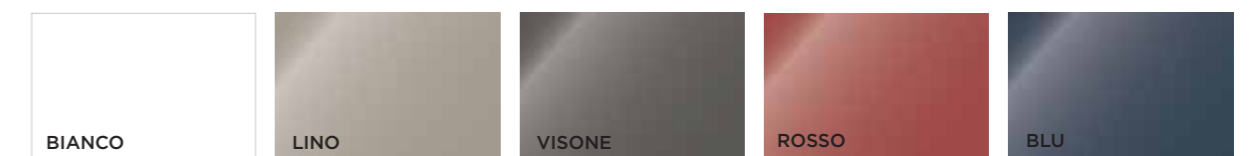

RESINA CEMENTO OSSIDI  
CONCRETE RESIN OXIDES



CONCEPT  
R&S Novacucina

DIGITAL IMAGES  
imagodesign

GRAPHIC DESIGN  
imagodesign

COPYWRITING  
Lisa Cadamuro

PRINTING  
Grafiche Italprint

LUGLIO 2017

Nova Cucina S.p.A.

Via Tessere, 8 • 33070 San Giovanni di Polcenigo  
Pordenone • Italy  
Tel. +39 0434 748791  
Fax +39 0434 740777

[www.novacucina.com](http://www.novacucina.com)  
[info@novacucina.com](mailto:info@novacucina.com)

by  
**Novacucina**

